

VESSEL ASSEMBLY

1. Print and cut out necessary vessel types and fold in half.
2. Per Fig. A., cut out coin slot at top and cut open a slit along the grey line at the bottom edge. *(The coin slot will hold the penny, and the base slit will fit over the Penny Stop, a short wall on the base designed to stop pennies rolling by).*
3. Fold the bottom feet inward to form a triangle and secure with glue or tape, keeping the slit open. See Fig. B.

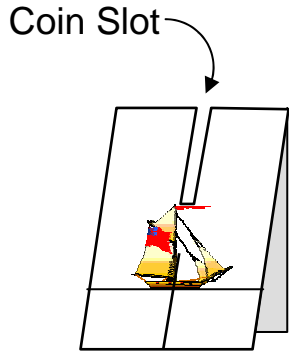

Figure A.

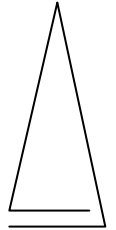
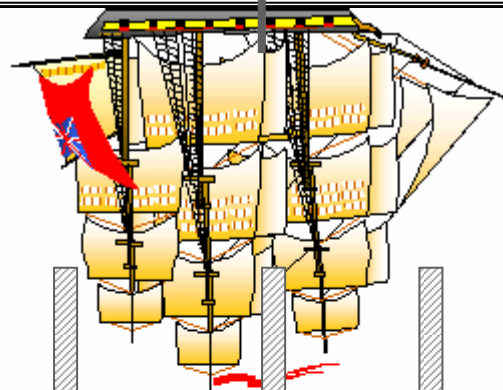
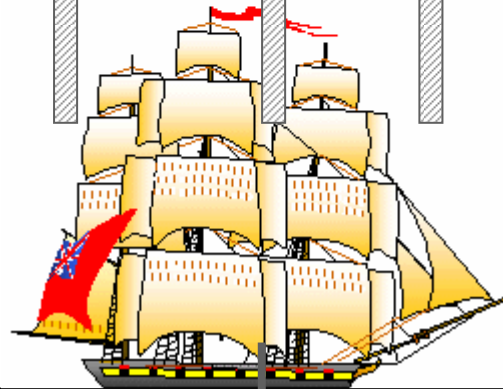

Figure B.

Fold



Fold



Fold

SHIP

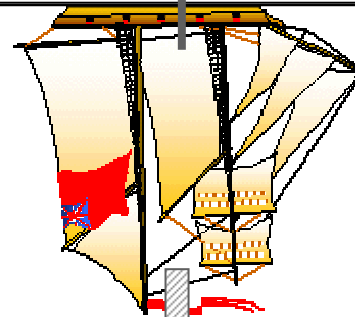

SCHOONER

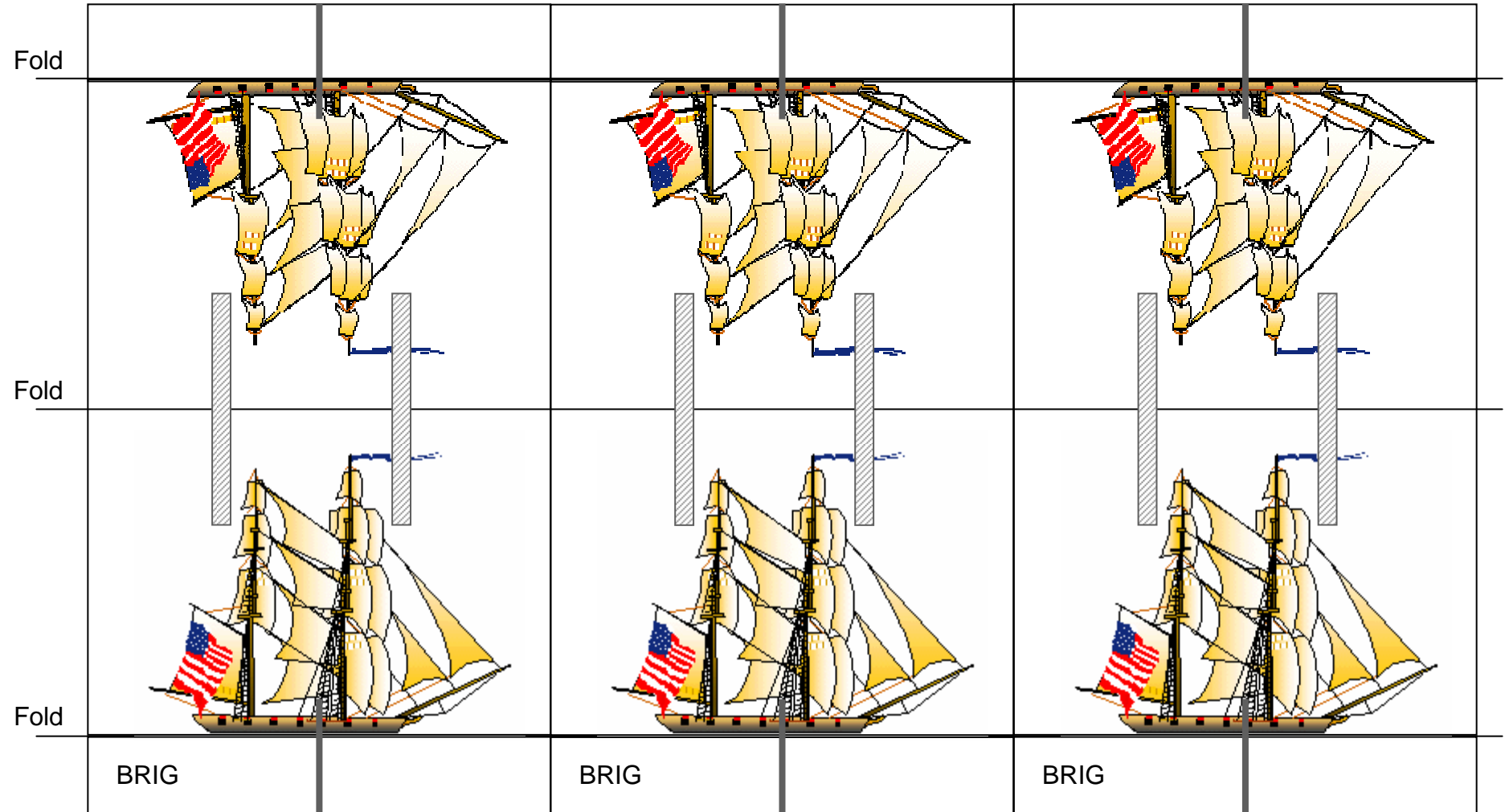

Fold

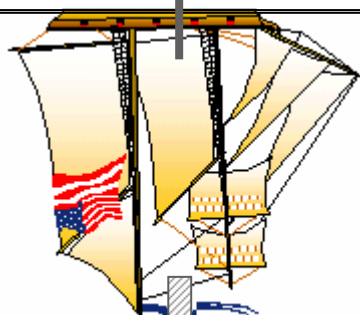
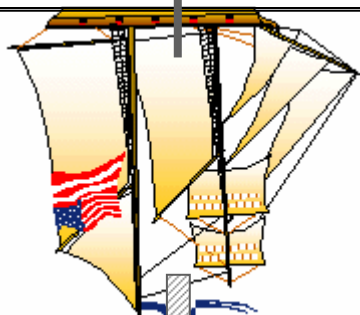
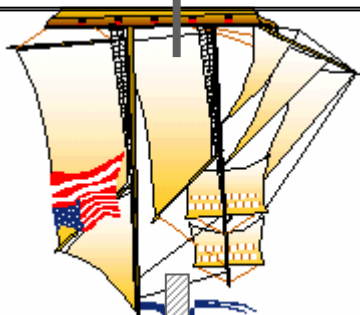

Fold



Fold

SCHOONER

SCHOONER

SCHOONER

Fold

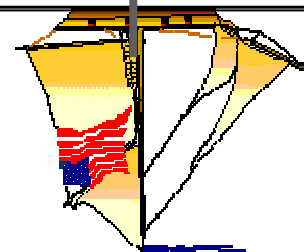
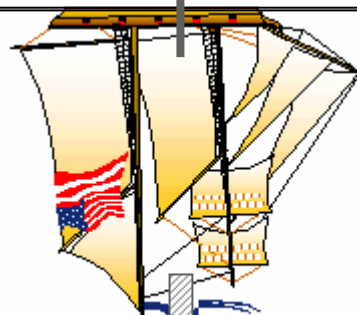
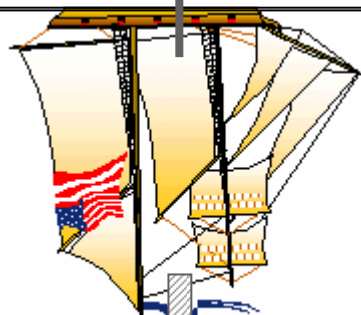

Fold

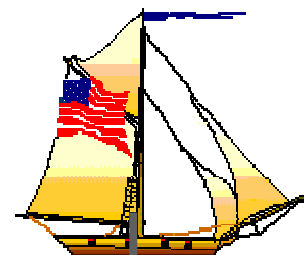

Fold

SCHOONER

SCHOONER

SLOOP

BASE ASSEMBLY

1. Print and cut out bases (You can print this version on blue paper).
2. Cut off the Penny Stop located along the end of the base. See Fig. A.
3. Fold Penny Stop at a right angle and secure to the base in the area bounded by the narrow dashed box, aligning folded edge with the side marked with the ◀ See Fig. B.

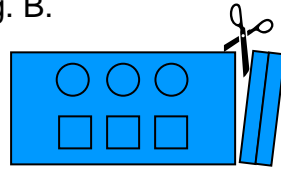

Figure A.

FINAL ASSEMBLY

1. Place the assembled vessel on top of the base with the bow facing toward the vessel's name, fitting the slit in the bottom over the Penny Stop, and glue or tape into position.
2. Place pennies in the coin slots, and you're ready for action. See Fig. C.

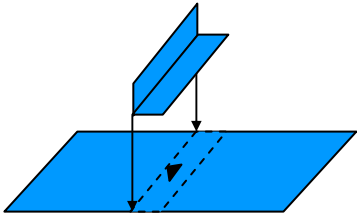

Figure B.

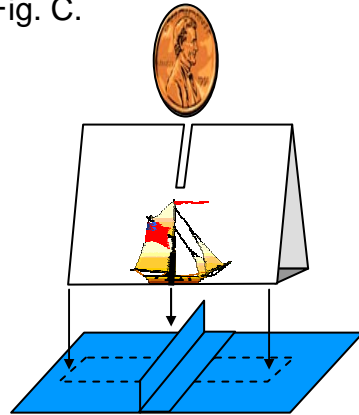
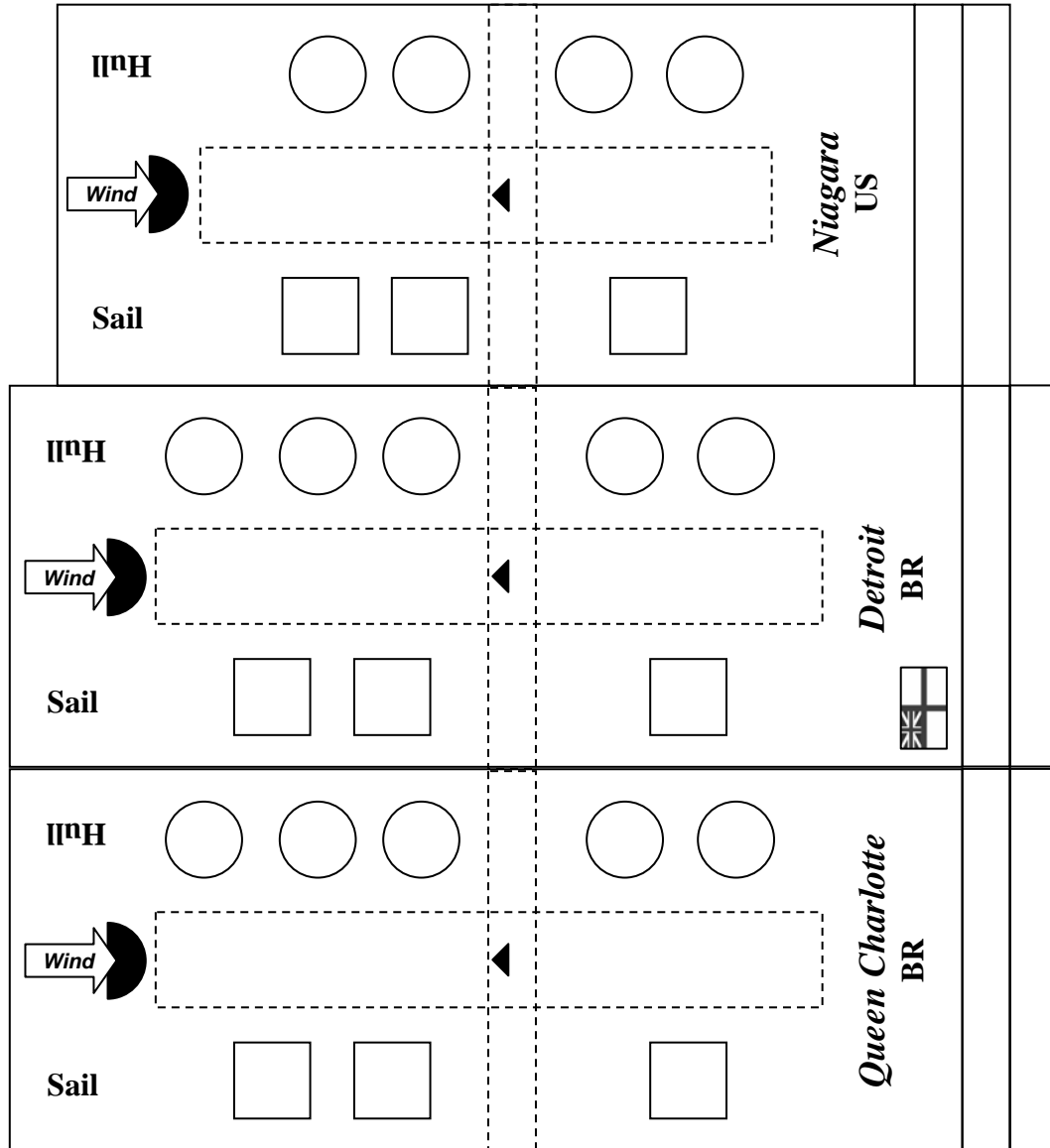
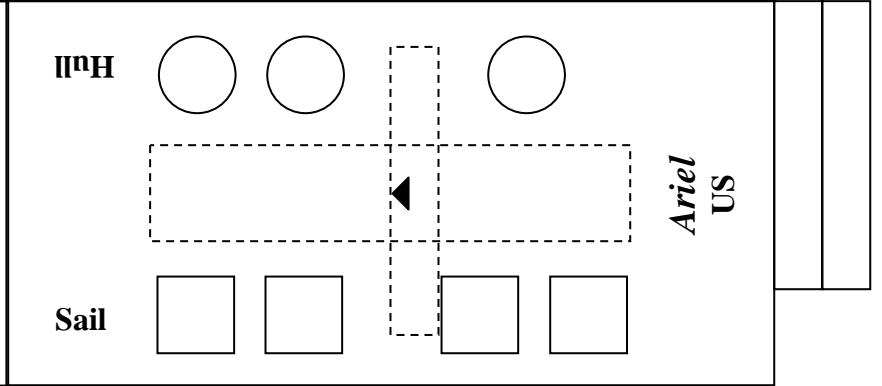
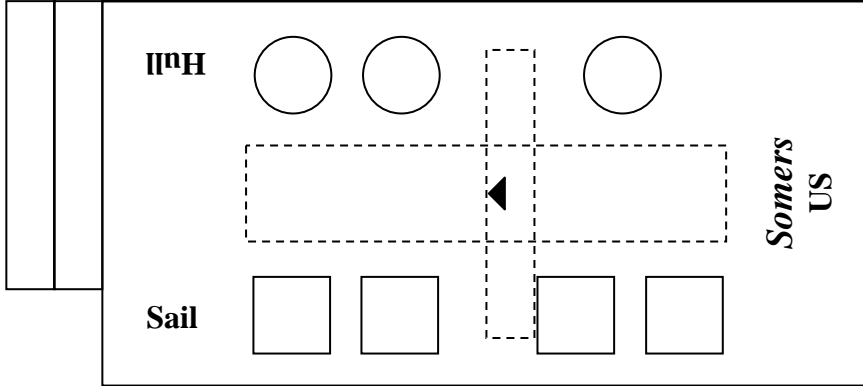
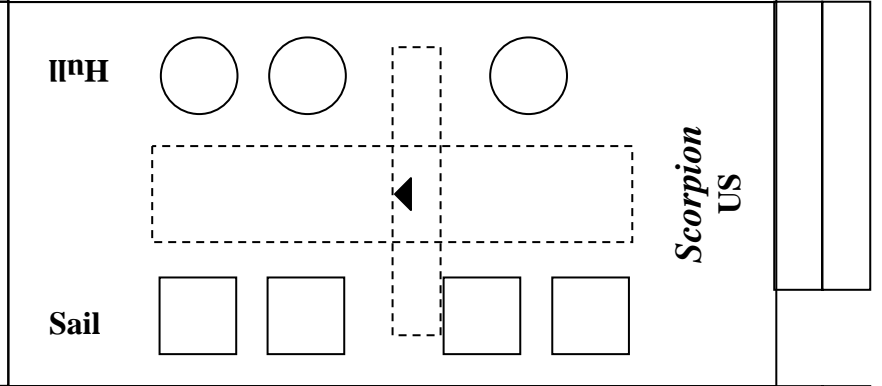
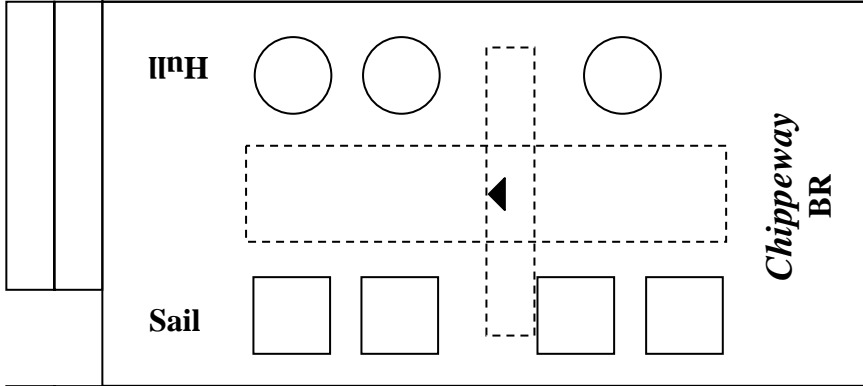
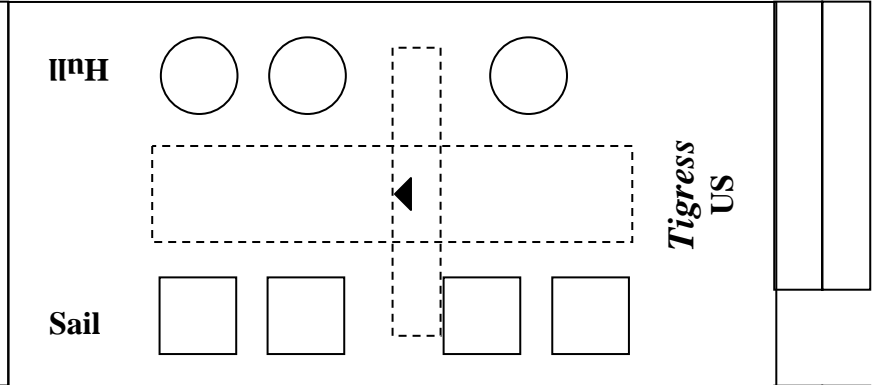
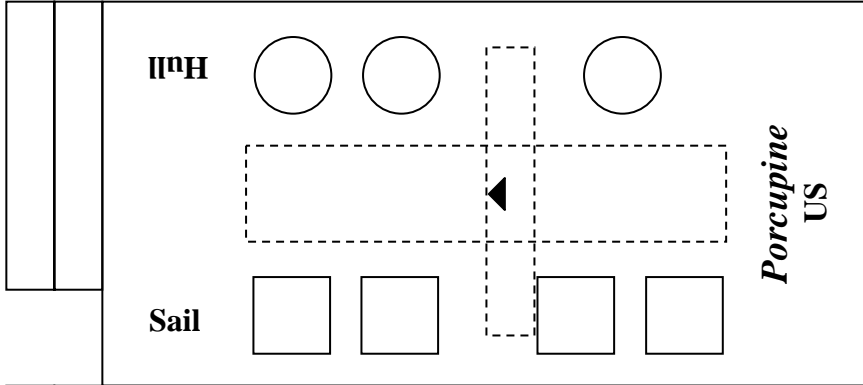

Figure C.

Penny Stop
↓





Hull

Sail

Little Belt
BR

Hull

Sail

Trippe
US

Hull

Sail

Lady Provost
BR

Hull

Sail

Lawrence
US

Hull

Sail

Hunter
BR

Hull

Sail

Caledonia
US

WIND MARKER

Cut out wind marker and fold into triangle as shown; glue or tape together. Place at edge of table with arrow pointing inward to indicate wind direction. If wind dies, tip marker over with arrow pointing up showing the No Wind face.

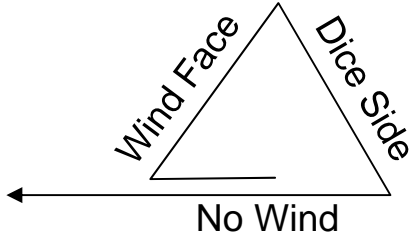

N, S, E, W COMPASS MARKERS

Cut out each compass marker and place along appropriate table edges.

